

PROCESS ANALYTICS FOR THE CHEMICAL INDUSTRY



**THE ART
OF MEASURING**

PROCESS ANALYTICS FOR THE CHEMICAL INDUSTRY

The chemical industry is characterized by an extremely high diversity of applications. Environmental conditions can be wet, highly corrosive, and toxic. Consequently, process safety combined with explosion protection and proven measurement technology have an important role to play. The measured values, e.g., for pH, often reach extreme levels (pH < 1, pH > 13) and this is associated with increased temperature and pressure. This places very high demands on the sensors. The range of corrosion-resistant special materials (Hastelloy, titanium, PEEK, Teflon) is just as essential as fittings tailored specifically to the application. Outside

Europe, the measurement technology is often installed completely outdoors, requiring particularly rugged measuring technology with enclosures made of coated stainless steel or corrosion-resistant, impact-resistant, UV-resistant polymers, for instance. This brochure presents applications that have been individually designed to meet the requirements of the operational environment and the customer's process. Is your measuring point subject to other conditions? No matter, our portfolio enables us to offer an optimal solution to almost any measuring task.

WHY KNICK?

Because Knick is known for rugged and durable products able to withstand even harsh environmental and measurement conditions. Co-developed and introduced to the market by Knick, contactless Memosens technology contributes to this. This combination of durable products with digital Memosens technology is ideally suited to the requirements of the chemical industry.

Even if the measuring task has special requirements, Knick is happy to accept the challenge!

By combining suitable, individually configurable products, we can offer you the right solution for your measuring task, e.g., using manually operated retractable fittings or the cCare fully automatic cleaning and calibration system.

Knick begins where others stop.

SERVICES THAT PAY OFF

Our expertise



PRODUCT-PORTFOLIO:

Modular system for fittings and transmitters for complete solutions from a single source



PERFECTION:

Thoughtful, all, even the simplest products are perfected in every detail.



PERFORMANCE:

Reliability and safety, ease of maintenance, security - with retractable armatures without interrupting the process



PROCESS RELIABILITY:

Accurate measurements, documentation of measured values, automatic measuring points, and predictive maintenance.

KNICK MEASURING PARAMETERS



PROCESS ANALYTICS FOR THE CHEMICAL INDUSTRY

Segments



1

FINE AND SPECIALTY CHEMICALS

Fine chemicals are produced as pure substances at multi-purpose plants using multi-stage chemical or biotechnological batch processes. They serve as the reactants for pharmaceuticals, biopharmaceuticals, and agrochemicals. Specialty chemicals are used because of their function, e.g. adhesives, agrochemicals, detergents, cosmetic additives, fragrances and food additives, flavors, construction chemicals, elastomers, polymers, lubricants, dyes or industrial gases. **MORE ON PAGE 4**



2

BASIC CHEMICALS

Basic chemicals (or commodity chemicals) are manufactured in large quantities. They are required as raw materials for important industrial mass-produced products such as plastics, dyes, surfactants, and fertilizers, but also for specialty products such as adhesives, pesticides, paints, preservatives, and fine chemicals. **MORE ON PAGE 8**



3

DYES AND PIGMENTS

Dyes (also called colorants) and pigments add color to a material, with the term dye often used for both dyes and pigments. The main difference between dyes and pigments is the particle size. Dyes are much finer than pigments. **MORE ON PAGE 14**



4

NUTRITION

The nutrition sector of the chemical industry deals with additives and feed material with a high degree of purity. These substances are biocompatible, enabling them to be used in food. Products of a lower quality are usually used in technical products. **MORE ON PAGE 20**



5

WASTEWATER

The wastewater sector deals with the treatment of industrial wastewater (not for municipal sewage treatment). Treatment systems can be found in almost every chemical company as well as in chemical parks where the wastewater from various companies is collected and neutralized. **MORE ON PAGE 24**



6

PRODUCT-SPECIFIC APPLICATIONS

In the field of safety and environment, the key focus is on protecting human and animal health as well as the environment from chemical hazards. **MORE ON PAGE 28**



MANUFACTURE OF HIGHLY DISPERSED SILICA

Online monitoring of pH and ORP values

Highly dispersed silica is to be found in countless everyday products. Its main function is as a fill material and it is used in many industries for food, pharmaceuticals, cosmetics, and technical products. The highly dispersed silica must have a corresponding quality to its use. This means that the process conditions must be regularly adjusted in order to achieve the required product characteristics. High-purity silica therefore requires sophisticated process control and highly efficient reactor dynamics.

To control the product properties of the highly dispersed silica, the pH and ORP values are measured. The reliability of the measurement is crucial to the product quality. Due to its high particle content, the process medium itself influences the performance of the inline sensors used. For this reason, frequent calibration of the sensors is necessary, often also with sensor replacement. The customer previously used flow-through fittings, which were replaced by Knick retractable fittings. By changing the online pH monitoring, the number of measuring points could be reduced from 4 to 2. The two pH and ORP Memosens sensors are each controlled by a Protos transmitter. Retractable fittings with standard DN50 flange were installed in DN100 piping. By using the manual retractable fitting, the maintenance of the sensors can now be carried out easily and without interruption to the process.

WHY KNICK?

Because the user was impressed by the manually operated WA133M retractable fitting with its simplicity of operation and the built-in safety functions for employee protection.

The maintenance costs have been significantly reduced as maintenance no longer requires a process shutdown. Furthermore, maintenance costs could also be reduced, as the operating times of the retractable fittings could be extended.

Customer

German, internationally active chemical company with more than 25 production sites throughout Europe, Asia, and America. The application was realized in Germany.

Measuring point

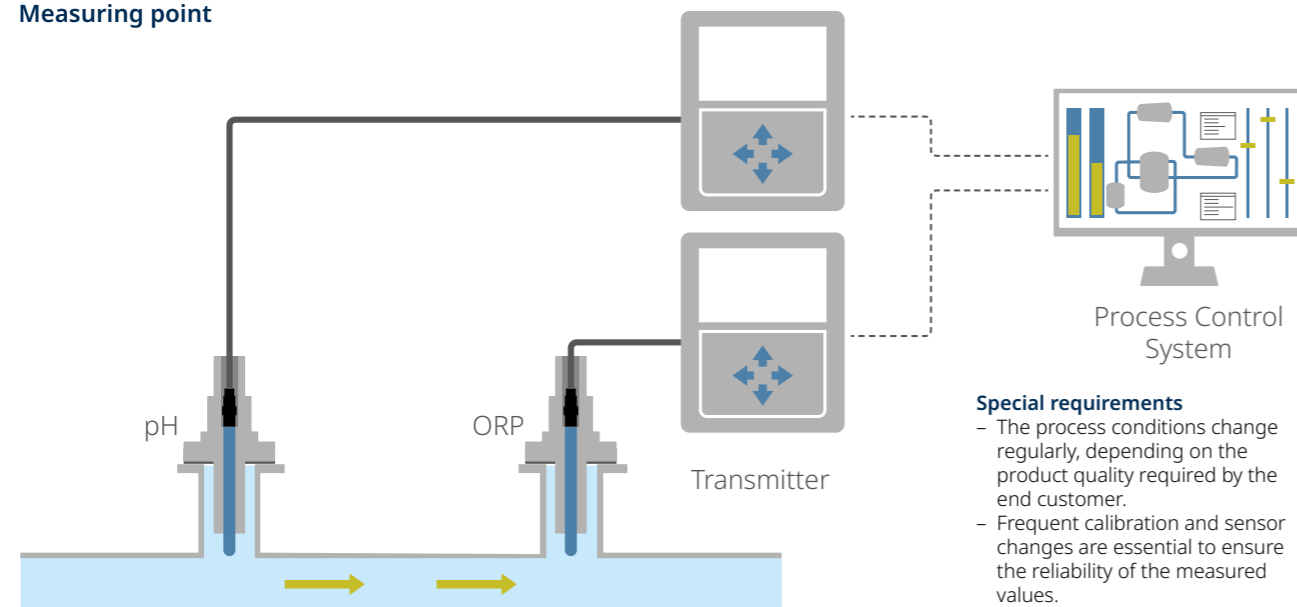

Special requirements

- The process conditions change regularly, depending on the product quality required by the end customer.
- Frequent calibration and sensor changes are essential to ensure the reliability of the measured values.

MANUFACTURE OF HIGHLY DISPERSED SILICA

Applications

PRODUCT

Protos



FEATURES

- High resolution graphic display
- Corrosion resistant coated stainless steel
- 4 wire, ex zone
- Full diagnostics
- Status messages according to NAMUR

CUSTOMER BENEFIT

- Various input and output connections for integration into process
- Flexible due to various modules for measuring and communication

PRODUCT

pH-Sensor SE555



FEATURES

- Up to 135 °C, up to 6 bar
- Ceramic junction
- Viscous, pressurized gel filling
- For aggressive media
- Memosens technology

CUSTOMER BENEFIT

- Long lifetime even in harsh conditions
- Remote calibration
- Sensor/cable connection can be submerged in water (Memosens)

PRODUCT

ORP-Sensor SE565



FEATURES

- Sensor element: platinum plate
- Up to 135 °C, up to 6 bar
- Ceramic junction
- Viscous, pressurized gel filling
- For aggressive media
- Memosens technology

CUSTOMER BENEFIT

- Long lifetime even in harsh conditions
- Remote calibration
- Sensor/cable connection can be submerged in water (Memosens)

PRODUCT

Manual Retractable Fitting SensoGate WA133M



FEATURES

- Manually operated retractable fitting for various sensor types
- 100 % sealed against process medium in any position of movement
- Various materials and process connections available

CUSTOMER BENEFIT

- Cleaning, calibration and change of sensor without process interruption
- Highest safety due to special interlocking mechanism

PRODUCT HIGHLIGHT

SE555X/X-AMSN

Combined pH and ORP measurement for high requirements in the chemical industry and for hygienic applications

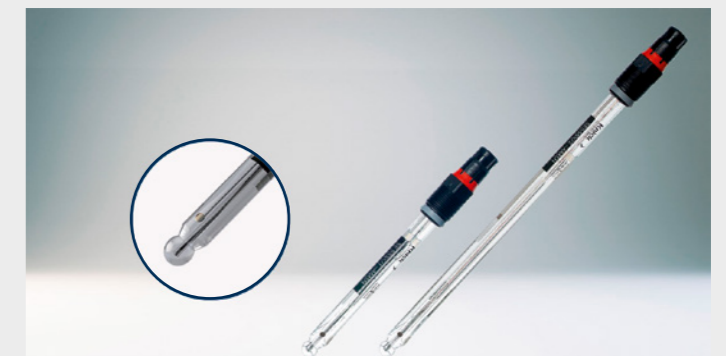

The SE555 pH and SE565 ORP sensors have been combined in one measurement sequence, saving space, cables, fittings, and transmitters at the installation site. The basis of the combined pH and redox sensor is the proven SE555 pH sensor, in which an additional platinum disk embedded in the side of the glass shaft enables measurement of ORP.



PHOSGENATION PROCESS IN PESTICIDE PRODUCTION

pH monitoring in the reaction with phosgene

Pesticides are used in agriculture to increase yield and profitability. The production of pesticides requires a great deal of technical expertise, as highly toxic chemicals such as phosgene are used in the process. This chemical is used predominantly in the production of isocyanates, an essential reactant for pesticides and polyurethanes. PU plastics are used in many building materials, varnishes, and adhesives. Phosgene itself is highly toxic (deadly poison gas) and is therefore produced directly on site and immediately converted in the subsequent reactions. Consequently, production facilities for phosgene are distributed across the world.

The main step in pesticide production is the reaction of phosgene with a basic pesticide component. This phosgenation process must be monitored using pH measurements. This ensures both product quality and process safety as hazardous side reactions are avoided through the pH-controlled addition of alkalis or acid. The highly toxic gas may only be used in hermetically sealed closed-loop systems. The measuring point was equipped with a cCare system that automatically cleans and calibrates the sensor to ensure accurate pH measurements. Safe sealing of the Ceramat to the process and minimization of maintenance costs ensure maximum safety for people and the environment.

WHY KNICK?

Because the cCare system makes it possible to automate the entire measuring point with 24/7 availability. Sensor cleaning and calibration take place during operation without involving personnel.

Only a sensor change or refilling of the buffer solution still require the intervention of maintenance staff, who can operate without risking a phosgene leak.

Customer

Globally operating chemicals group (pharmaceuticals, consumer health, crop science)

Measuring point

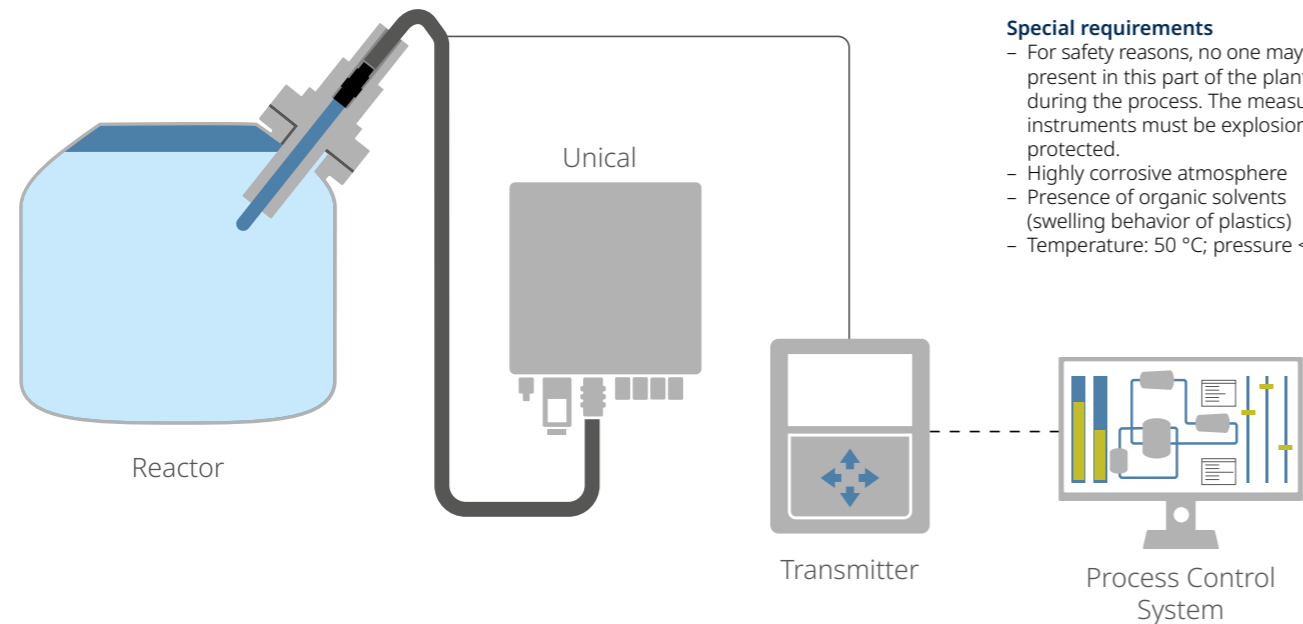

cCare

Fully Automated Sensor Maintenance System

Special requirements

- For safety reasons, no one may be present in this part of the plant during the process. The measuring instruments must be explosion protected.
- Highly corrosive atmosphere
- Presence of organic solvents (swelling behavior of plastics)
- Temperature: 50 °C; pressure < 1 bar

PHOSGENATION PROCESS IN PESTICIDE PRODUCTION

Applications

PRODUCT

Protos



FEATURES

- High resolution graphic display
- Corrosion resistant coated stainless steel
- 4 wire, ex zone
- Full diagnostics
- Status messages according to NAMUR

CUSTOMER BENEFIT

- Various input and output connections for integration into process
- Flexible due to various modules for measuring and communication

PRODUCT

pH-Sensor SE571



FEATURES

- Up to 130 °C, up to 12 bar
- PTFE ring junction
- Ag/AgCl, incl. silver ion trap and saltreservoir
- No contamination or blocking of the junction
- Memosens technology

CUSTOMER BENEFIT

- Long lifetime even in harsh conditions
- Remote calibration
- Sensor/cable connection can be submerged in water (Memosens)
- SE 571 annular junction resists fouling

PRODUCT

Unical/Uniclean



FEATURES

- Automatic cleaning and calibration of pH measuring point
- Timer or remote controlled
- Available in ex zone
- Easy installation and operation

CUSTOMER BENEFIT

- All media (air, water, cleaning and calibration solutions) are connected in one tubing and by one connector plug
- Local switch for maintenance

PRODUCT

Retractable fitting Ceramat WA150



FEATURES

- Ceramic lock-gate sealing for long life in corrosive and abrasive suspensions
- No gaskets, lowest maintenance
- Available in ex zone

CUSTOMER BENEFIT

- Lowest maintenance
- Long service life
- Effective cleaning and protection of sensor

PRODUCT HIGHLIGHT

Ceramat

For tough applications

Patented retractable fitting with ceramic sealing to the process. Harder than steel. Designed as a solution to difficult applications in which conventional fittings with O-ring seals fail.

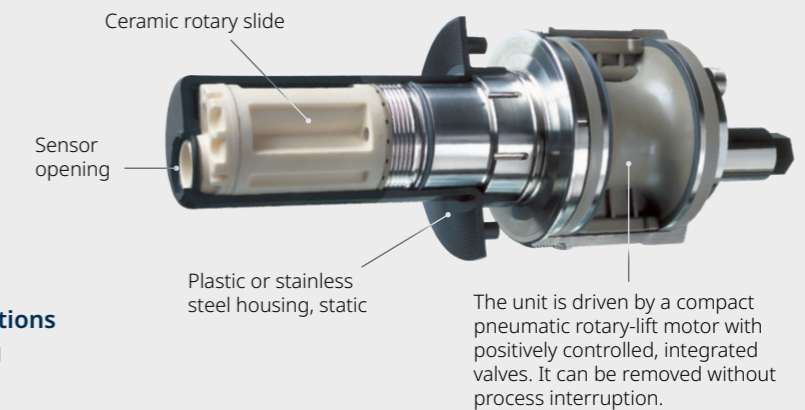



CONTROL OF THE MEDIUM IN CHLOR-ALKALI ELECTROLYSIS

pH measurement in saturated saline solution

Chlor-alkali electrolysis is an important industrial process for the large-scale manufacture of chlorine, sodium hydroxide, and hydrogen. The process involves saline solutions (usually NaCl solutions) being subjected to electrolysis to produce the products mentioned.

There are three types of process worldwide: the amalgam, diaphragm, and membrane processes. For reasons of environmental protection and yield, the membrane process is the leading process for alkaline electrolysis today.

pH control of the medium to be electrolyzed is mandatory throughout the entire process of chlor-alkali electrolysis.

Measurement of pH and ORP is required in brine preparation when sodium chloride is dissolved as a raw material in water or added to the

anolyte directly from the electrolysis process to be reused in the process. To ensure that the pH measurement in this step is very accurate and thus obtain optimal process conditions, very strict specifications must be followed. The anolyte may be toxified with chlorine or chlorate, which must be removed in the recycling process and before starting new electrolysis reactions. The catholyte is a sodium hydroxide solution that must have a precisely defined concentration of sodium hydroxide (~30 wt-%) in order to allow the process to run optimally. The SE555 pH sensor used in the process has a long service life despite the harsh conditions and can be used not only in the electrolysis of sodium salt solutions, but also in the electrolysis of potassium salts. This makes this type of sensor an all-rounder for this application.

WHY KNICK?

Because at the industrial park where the chlor-alkali electrolysis plant is located, the Protos transmitter has proven to be operationally satisfactory for many years, even in hazardous areas.

Knick also offers digital Memosens technology, which is resistant to electric fields or interference potential that may occur in electrolysis systems.

The Memosens SE555 pH sensor used for this application has a long service life and can be used in the electrolysis of both sodium and potassium salts. In addition, this sensor does not require special pH buffer solutions.

Customer

Manufacturer of basic chemicals for different industries, from the construction and cleaning sectors to the pharmaceutical industry and water treatment with production facilities in Europe.

BRINE PURIFICATION AND RECYCLING IN CHLOR-ALKALI ELECTROLYSIS

Monitoring of electrode toxins with ORP measurement

The used brine/anolyte is returned to the process from the electrolytic cells. However, before this happens, the electrode poisons of chlorine or chlorates that may be contained in it must be removed before the brine can be enriched with further salt and returned to the electrolysis.

An inaccurate measurement of the ORP will not correctly detect the presence or removal of chlorine or chlorates. This has several disadvantages, which are clearly reflected in the process flow:

- Shortening the service life of the pH and ORP sensors used
 - Impairment of the process of electrolysis, potentially leading to malfunction
 - Damage to system components
- Therefore, accurate ORP measurement is essential in the brine recycling process.

Special requirements

- For pH values between 10-11 at a temperature around 60° C, very accurate and redundant pH measurements are required.
- The process produces electrode-poisoning substances such as chlorine or chlorate, leading to measurement errors/loss of accuracy and a significant shortening of the service life of the pH sensor.
- Corrosive environment.
- Use of glass fiber reinforced piping (FRP) promotes stray currents, which generate stray electrostatic currents that become non-critical due to the MS technology

WHY KNICK?

Because the Memosens SE554 sensors met the required measurement tolerance without product calibration within 30 days of installation. Memosens eliminated the effects of stray currents and corrosion on the sensor head, increasing the stability of the measurement and extending the service life of the sensor. SE564 and 554 have exceptional performance characteristics in dechlorinated brine despite the alkaline pH range at elevated temperatures.

Customer

International manufacturer and supplier of petrochemicals and polymers based in Houston/Tx.

Measuring point

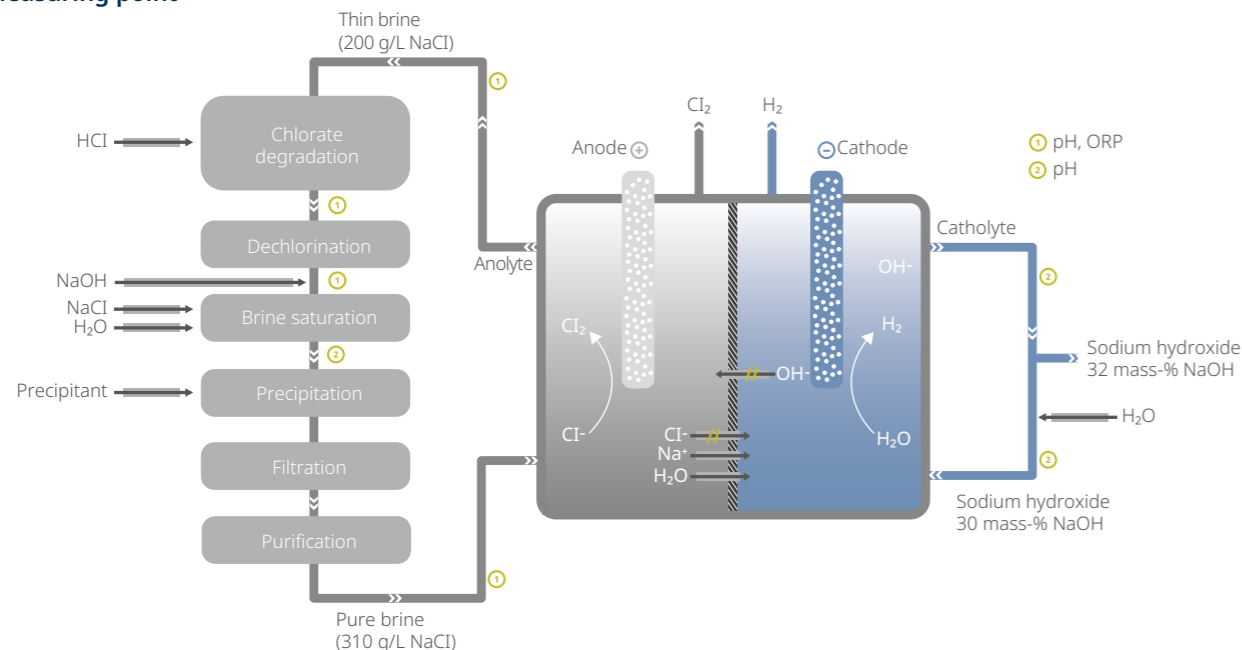

Process

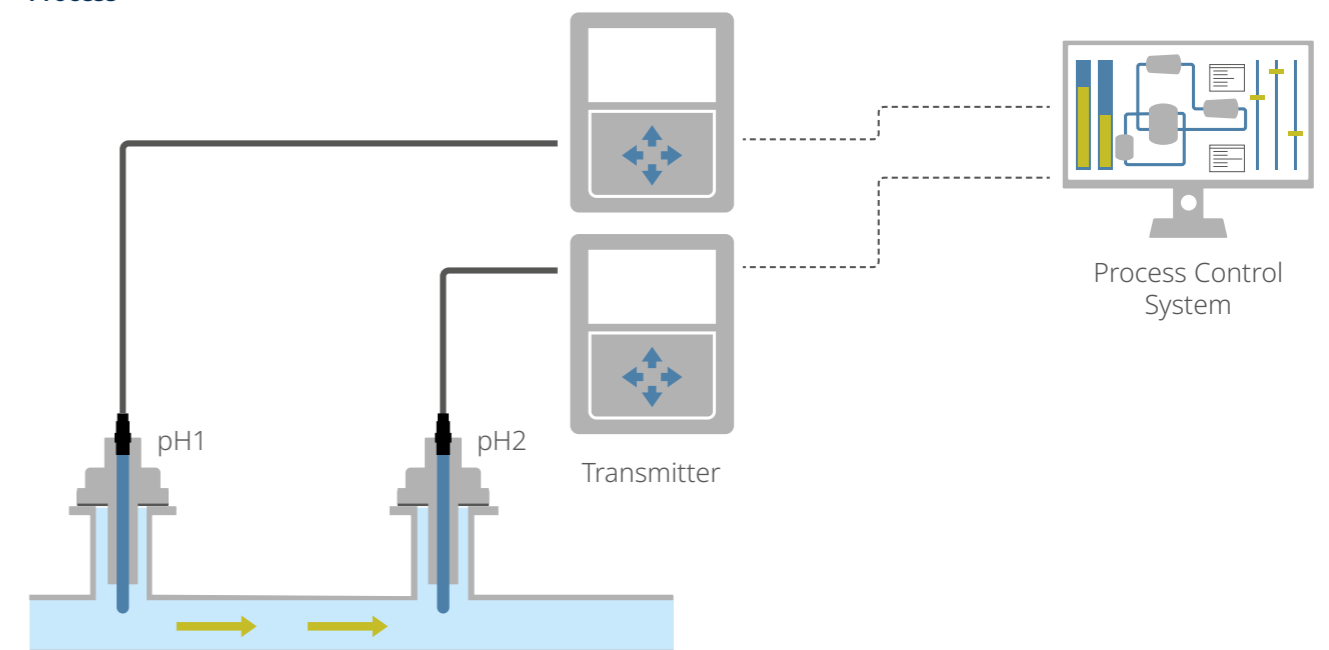

CONTROL OF THE MEDIUM IN CHLOR-ALKALI ELECTROLYSIS

Applications

PRODUCT

Protos



FEATURES

- High resolution graphic display
- Corrosion resistant coated stainless steel
- 4 wire, ex zone
- Full diagnostics
- Status messages according to NAMUR

CUSTOMER BENEFIT

- Various input and output connections for integration into process
- Flexible due to various modules for measuring and communication

PRODUCT

pH-Sensor SE555



FEATURES

- Up to 135 °C, up to 6 bar
- Ceramic junction
- Viscous, pressurized gel filling
- For aggressive media
- Memosens technology

CUSTOMER BENEFIT

- Long lifetime even in harsh conditions
- Remote calibration
- Sensor/cable connection can be submerged in water (Memosens)

BRINE PURIFICATION AND RECYCLING IN CHLOR-ALKALI ELECTROLYSIS

Applications

PRODUCT

Stratos Pro



FEATURES

- 2-wire-analyzer for pH / ORP, conductivity or oxygen
- For analog, digital and Memosens-sensors; automatic sensor identification
- High-contrast widescreen display with colored backlighting

CUSTOMER BENEFIT

- Comprehensive features
- Intuitive operation with pictograms and continuously plain-text ticker line
- Shatter-proof and corrosion-resistant housing

PRODUCT

pH-Sensor SE554



FEATURES

- Up to 130 °C, up to 10 bar
- 2x open hole
- Solid polymer
- For heavy industrial application with a lot of impurities and precipitations
- Memosens technology

CUSTOMER BENEFIT

- Long lifetime even in harsh conditions
- Remote calibration
- Sensor/cable connection can be submerged in water (Memosens)

PRODUCT HIGHLIGHT

Stratos Pro

2-wire analyzers with high flexibility for pH / ORP, conductivity or oxygen under harsh environmental conditions and in hazardous areas. Conventional analog and digital sensors are supported as well as Memosens technology.



With its exceptional range of functions and application-oriented design, Stratos is well-established in the entire chemicals industry, in process and power plant engineering and in the pharmaceutical and biotechnology industries. Suitable for all conceivable indoor and outdoor scenarios, the Stratos brand is today a synonym for innovation and reliability in process applications around the world.

Comprehensive features

The devices can be used in multidrop mode and are certified for asset management systems of the leading manufacturers. Stratos Pro features two digital control inputs as well as an analog input and a second optional power output for a further measured value.

Unique color-coded user interface

Stratos Pro is equipped with a color screen backlighting which requires an absolute minimum of electrical power. To reduce operator errors, the high-contrast widescreen display clearly indicates the current operating mode in six different color tones. Scrolling plain text messages and self-explanatory icons simplify operation.

Shatter-proof and corrosion-resistant housing

The IP67 enclosure made of PBT is reinforced and UV protected. Safe operation is guaranteed in the range from -20°C to +65°C, even for applications in hazardous locations.

TECHNIC AND FEATURES

- Digital communication via PROFIBUS-PA, FOUNDATION-Fieldbus or HART
- Automatic sensor identification
- Sensor diagnostic with wear indication, remaining lifetime, CIP/SIP counter and adaptive calibration timer
- IP67/NEMA 4X protection
- Device versions for use in temperature class T6
- Ex-Schutz Zone 1 / Class 1 Division 1 (mit Sensor in Zone 0)



HYDROGEN CYANIDE PRODUCTION

Monitoring of the process through pH control

Hydrogen cyanide HCN (hydrocyanic acid) is an important base chemical that is used as a reactant in numerous organic syntheses, e.g., in the manufacture of methacrylic acid esters (in acrylic glass, dental prostheses, and bone cement) or lactic acid as a polyamide precursor. Hydrogen cyanide is also used in pharmaceuticals and agrochemicals, in mining, and in the metallurgical industry. Due to its high toxicity and the risk of explosive polymerization, hydrocyanic acid is further processed directly and without storage. There are several industrial processes for the production of hydrogen cyanide, in this application by formamide cleavage, in which hydrogen cyanide is separated.

The catalytic dehydration of gaseous formamide (HCONH₂) using catalysts for reaction acceleration produces hydrogen cyanide and water. In this separation process, the pH value in the reaction must be permanently monitored. Regular cleaning, calibration, and function checks of the pH sensor are required to ensure that the process remains stable without interruption and there is no risk of releasing hydrogen cyanide under any circumstances. The measuring task required a safe, self-sufficient, low-maintenance, and industry-proven measuring system. For this reason, a cCare system was installed in the application. In order to avoid endangering the users, the components that still require a low level of maintenance (refilling of the media containers with pH buffer solutions) were installed in a safe area, while the retractable fitting is located in the danger zone.

WHY KNICK?

Because the unique cCare system contributes significantly to the safety of people and the environment, as it minimizes hazardous risks during maintenance work in the HCN system.

Fully automatic cleaning, calibration, and function checks in combination with the low-maintenance Ceramat retractable fitting extend the maintenance interval, thereby also reducing maintenance costs and enabling the measuring point to be operated around the clock.

Customer

Largest chemical producer in the world with subsidiaries/joint ventures in more than 80 countries and 390 production sites in Europe, Asia, Australia, America, and Africa

Measuring point

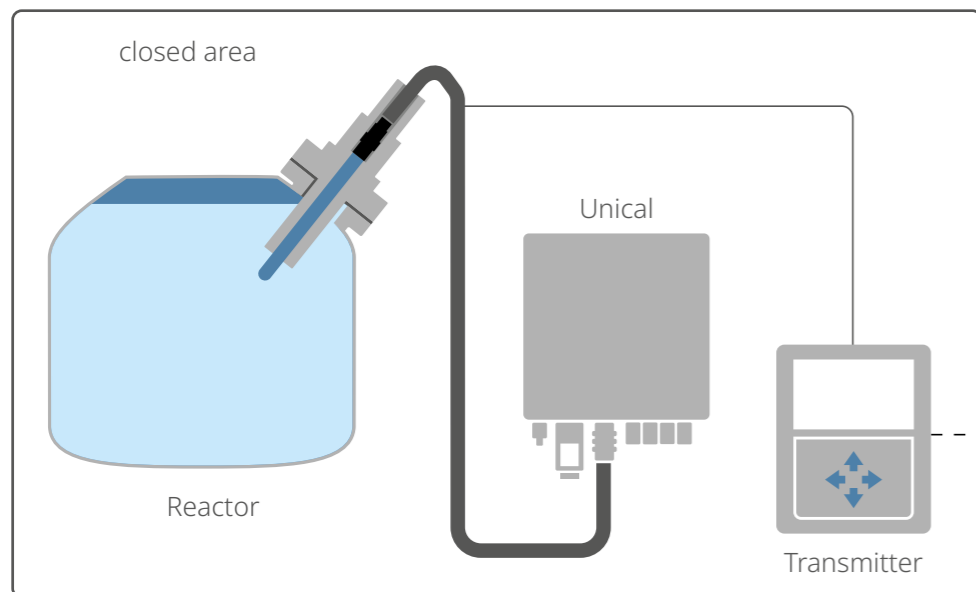

cCare

Fully Automated Sensor Maintenance System

Special requirements

- System must work autonomously, as it is located in a closed area with prohibited access and a powerful ventilation system.
- The sensor may only be changed following process interruption and complete decontamination.

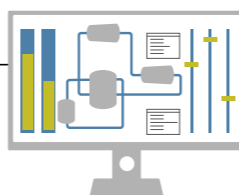

Process Control System

HYDROGEN CYANIDE PRODUCTION

Applications

PRODUCT

Protos



FEATURES

- High resolution graphic display
- Corrosion resistant coated stainless steel wire, ex zone
- Full diagnostics
- Status messages according to NAMUR

CUSTOMER BENEFIT

- Various input and output connections for integration into process
- Flexible due to various modules for measuring and communication

PRODUCT

pH-Sensor SE557



FEATURES

- Pressurized liquid electrolyte
- No blocking of the diaphragm
- Minimization of cyanide poisoning of the reference system
- Can be pre-calibrated in the laboratory
- Memosens technology

CUSTOMER BENEFIT

- Refillable liquid electrolyte
- Maximum service life

PRODUCT

Unical/Uniclean



FEATURES

- Automatic cleaning and calibration of pH measuring point
- Timer or remote controlled
- Available in ex zone
- Easy installation and operation

CUSTOMER BENEFIT

- All media (air, water, cleaning and calibration solutions) are connected in one tubing and by one connector plug
- Local switch for maintenance

PRODUCT

Retractable fitting Ceramat WA150



FEATURES

- Ceramic lock-gate sealing for long life in corrosive and abrasive suspensions
- No gaskets, lowest maintenance
- Available in ex zone

CUSTOMER BENEFIT

- Lowest maintenance
- Long service life
- Effective cleaning and protection of sensor

PRODUCT HIGHLIGHT

Memosens

Contactless sensor coupling for reliable liquid analysis

The 4 Advantages

<p>1 Contactless coupling</p> <p>Interference-free coupling - reliable functioning in all environments</p>	<p>3 Intelligent diagnostics</p> <p>Predictive maintenance - reliable process management thanks to special intelligent diagnostics</p>
<p>2 Pre-calibrated sensors</p> <p>Operating cost reduction with pre-calibrated sensors</p>	<p>4 Memosens mobile</p> <p>Memosens mobile - raster, more accurate diagnostics under real conditions with a portable transmitter</p>

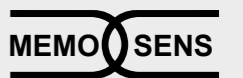



COLOR PIGMENT MANUFACTURE

pH measurement during dye synthesis

A pigment is a colored material that is completely or almost insoluble in water. Pigments are used in many applications and products worldwide, e.g., in oil paints, varnishes, emulsion paints, printing inks and colored pencils, white pigments, fillers in paper production, for dyeing textiles, plastics, cosmetics, candles, glass, and more. Pigment synthesis is similar to the processes for other poorly soluble chemicals, but there are differences associated with the application properties of color pigments such as light, weather, heat, and chemical resistance, as well as their dispersibility. Dye syntheses run around the clock in 4-shift operation in modern plants.

Practically all the key reaction steps in pigment production are pH value-dependent, so optimization of the product yield is based on reliable and low-maintenance pH measurement. For reasons of system availability, the pH measurements are configured redundantly. In the process itself, large amounts of hydrochloric acid are used for the actual reaction step (diazotization) at temperatures around 90 °C, which can corrosively attack the equipment used. As a result, the reactors are usually covered with a layer of enamel to prevent damage being caused by the conditions. The Ceramat WA150 in combination with the cCare automatic cleaning and calibration system and a refillable SE557 pH electrode allows for the full automation of this difficult measuring point with the highest level of accuracy and availability.

WHY KNICK?

Because the cCare system ensures optimization of the process, which in addition to the significant reduction of maintenance work at the measuring point, increases availability of the equipment.

Even after 24 months of operation, the Ceramat shows no signs of wear, enabling the maintenance to be significantly reduced to just once a year.

Customer

Globally active manufacturer of color pigment with headquarters in Japan, specializing in high-performance pigments, effect pigments for the cosmetics industry, and inorganic special pigments.

Process

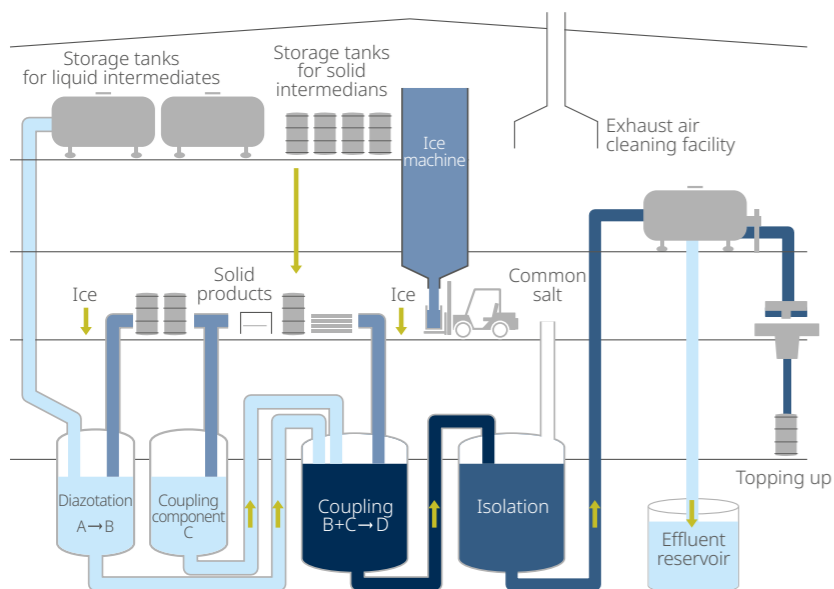

cCare

Fully Automated Sensor Maintenance System

Special requirements

- pH value 1, temperature 90 °C, pressure x6 bar. Very accurate - pH measurements are required.
- pH sensors have a life of between 8 hours and several weeks. Pigments block the pH sensor, so regular cleaning is required during the process.

COLOR PIGMENT MANUFACTURE

Applications

PRODUCT

Protos



FEATURES

- High resolution graphic display
- Corrosion resistant coated stainless steel
- 4 wire, ex zone
- Full diagnostics
- Status messages according to NAMUR

CUSTOMER BENEFIT

- Various input and output connections for integration into process
- Flexible due to various modules for measuring and communication

PRODUCT

pH-Sensor SE557



FEATURES

- Pressurized liquid electrolyte
- No blocking of the diaphragm
- Minimization of poisoning of the reference system
- Can be pre-calibrated in the laboratory
- Memosens technology

CUSTOMER BENEFIT

- Refillable liquid electrolyte
- Maximum service life

PRODUCT

Unical/Uniclean



FEATURES

- Automatic cleaning and calibration of pH measuring point
- Timer or remote controlled
- Available in ex zone
- Easy installation and operation

CUSTOMER BENEFIT

- All media (air, water, cleaning and calibration solutions) are connected in one tubing and by one connector plug
- Local switch for maintenance

PRODUCT

Retractable fitting Ceramat WA150



FEATURES

- Ceramic lock-gate sealing for long life in corrosive and abrasive suspensions
- No gaskets, lowest maintenance
- Available in ex zone

CUSTOMER BENEFIT

- Lowest maintenance
- Long service life
- Effective cleaning and protection of sensor

PRODUCT HIGHLIGHT

pH-Sensor SE557

Self cleaning due to pressurization

For special requirements and high-precision measurements with refillable liquid electrolyte, digital, with Memosens technology. With integrated, refillable liquid electrolyte reservoir for self-cleaning through pressurized, continuous electrolyte outflow. Available in Alpha and Omega glass.



Refillable liquid electrolyte

2 ceramic junctions and integrated temperature detector

PRODUCT HIGHLIGHTS

pH-Sensors

With application-specific properties

pH sensors from Knick have been developed and optimized in close cooperation with users for a wide range of applications. Special glasses, a large variety of junctions (open, PTFE, ceramic, platinum), special reference systems, analog or, of course, digital with Memosens – Knick has the right sensor for every application.

- Alpha glass Medium impedance, universal glass, fluoride resistant
- Sigma glass Low impedance for low-temperature-applications
- Omega glass High impedance for high-temperature applications, minimal alkali error, CIP/SIP-capable



Conductivity Sensors

For the complete range of aqueous solutions.

The conductivity of aqueous solutions covers a range of more than eight decades, starting with 0.055 µS/cm for ultrapure water and going as far as over 1,000 mS/cm for fully dissociated acids or bases. These very different requirements are fulfilled by special Knick sensors. Depending on the application, they come as two- or four-electrode sensors or toroidal sensors.

All sensors are equipped with a temperature detector for automatic temperature compensation..



Protos

The modular premium transmitter for all requirements. Versatile. Expandable. Ensuring Process Safety.



The Protos premium transmitter is a flexible, 4-wire device for the following process variables: pH, ORP, conductivity and oxygen. For monitoring and controlling processes even in the most complex applications – also in hazardous areas. With modular hardware and firmware concept.

Retrofits possible Future-Proof
Protos features a unique modular design and freely accessible wiring with a clear layout. The option for easy retrofitting and upgrading ensure planning security today and in the future. Different Ethernet and Fieldbus modules enable digital communication and seamless integration into automation systems.

Wide Sensor Selection
Protos is the only process analysis system that can be flexibly combined with Memosens and other digital or analog sensors – in multi-channel mode as well. With Memosens technology, up to 4 measuring channels can be implemented in parallel.

Status Messages ACC. to NE 107
All status messages for maintenance requests, failure, out of specification, and function check (HOLD) are output as specified in NE 107.



Reliable and safe thanks to Memosens-Technology
Digital sensors with inductive signal transmission – contact-less sensor couplings ensure the reliable analysis of liquid in all environments. Sensors that are precalibrated in the laboratory deliver maximum availability and reduced maintenance efforts at the point of measurement. Sensors can be replaced on site in just a matter of seconds
– Perfect galvanic isolation
– Fully resistant to moisture, dirt, corrosion, and interference potentials

- TECHNIC AND FEATURES**
- Stainless steel design with corrosion-proof powder coating for harsh industrial areas
 - Universal broad-range power supply 24 ... 230 V AC/DC
 - Rugged; can also be used outdoors (with IP 65 protection and UV resistance)
 - Panel, wall or post/pipe-mounting
 - High-contrast graphic LC display
 - Memory card concept for data recording, firmware updates, and Audit Trail
 - Freely combinable measuring, control, and communication modules



INK MANAGEMENT IN PRINTING PRESSES

pH value and temperature measurement in ink

Even in the digital age, printed media are still very popular and important. Newspapers, adverts, placards, posters, package inserts, manuals, descriptions, etc. are just a few examples. In addition to paper or cardboard in various qualities, printing of these media also requires special inks which differ in drying and curing. Large printing presses are equipped with drying systems, as curing has a decisive influence on the quality of the print image and the durability of the often viscous inks. Each ink requires its own pH and temperature measurement, as these parameters directly affect the curing properties. The life of the sensors used depends significantly on the viscosity of the ink.

A manufacturer of drying systems for up to 7 different inks had already used some cost-effective, analog pH devices from various suppliers. However, with these devices, there were repeated interruptions due to choked sensor diaphragms, leading to time-consuming maintenance for the end customer. The space-saving process solution with the compact MemoRail transmitter could be easily integrated into the overall system and has already been implemented in several machines. The pH sensors with Memosens technology are particularly user-friendly and can be easily calibrated offline using the Portavo hand-held measuring device. The calibration data is stored in the connector, enabling customers to also keep pre-calibrated sensors in the warehouse.

WHY KNICK?

Because the compact MemoRail transmitter facilitates an easy-to-install and easy-to-operate measuring point taking up little space in the overall system.

Memosens technology allows for offline calibration with the rugged Portavo hand-held measuring device, providing the customer with easier sensor maintenance. As a result, the user only has minimal downtime.

Customer

The US customer develops and manufactures standard devices and customer-specific designs for drying, curing, plate cleaning, and color management systems for the printing and print processing industry.

Measuring point

Special requirements

- The dryer unit must be notified of the pH value and temperature parameters for the up to 7 inks.
- The Knick devices should be able to be installed within the overall system by the device manufacturer and should not block the sensors.

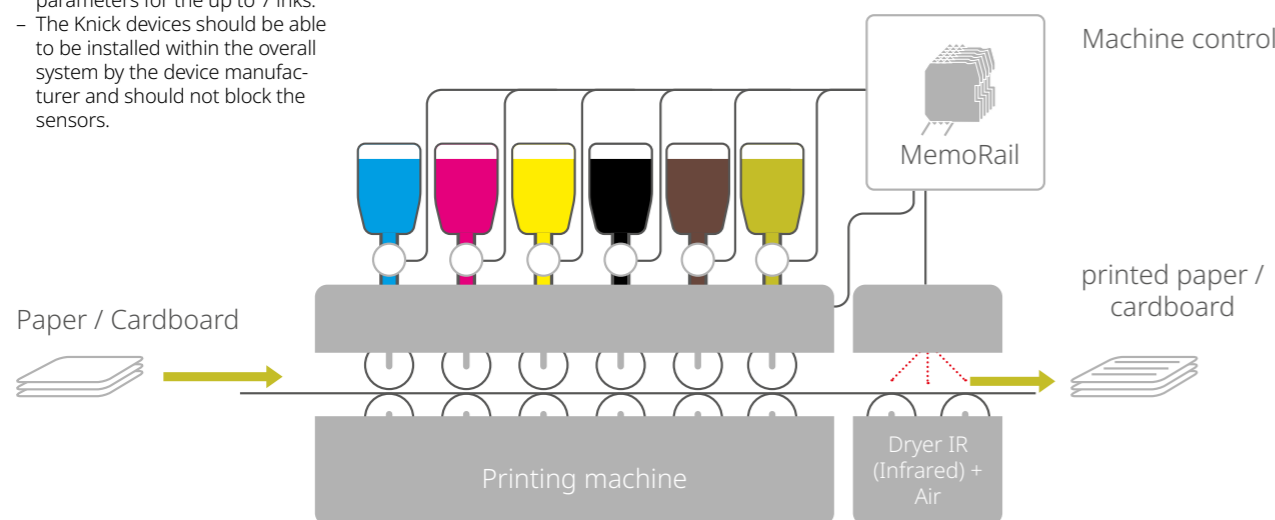

INK MANAGEMENT IN PRINTING PRESSES

Applications

PRODUCT

MemoRail A1401



FEATURES

- Compact design and cost saving
- Single and dual channel
- MemoSuite technology
- Optional Modbus output

CUSTOMER BENEFIT

- Cost effective solution for many measuring locations
- Easy remote calibration by using the MemoSuite software

PRODUCT

Portavo 907 Multi



FEATURES

- Portable multiparameter analyzer for digital pH/ORP, conductivity, and oxygen sensors with Memosens technology
- simultaneous measurement with Memosens sensors
- Measurement data display/storage in the device

CUSTOMER BENEFIT

- pH calibration procedure with a fixed process cycle
- Robust, practical, comfortable
- Li-ion battery, direct via USB rechargeable

PRODUCT

pH-Sensor SE555



FEATURES

- Up to 135 °C, up to 6 bar
- Ceramic junction
- Viscous pressurized gel filling
- For aggressive media
- Memosens technology

CUSTOMER BENEFIT

- Long lifetime even in harsh conditions
- Remote calibration
- Sensor/cable connection can be submerged in water (Memosens)

PRODUCT HIGHLIGHT

MemoRail

The Essence of Measuring.



Maximum Performance in a Minimum of Space

MemoRail is the first genuinely compact, digital analyzer for measuring pH values, ORP, conductivity, oxygen and temperature with Memosens sensors. Two analog active / passive 4 to 20 mA outputs supply the measured values for the process control system or a PLC.

Plug & Measure

MemoRail is immediately ready for measurement on connecting a pre-calibrated Memosens sensor. "Used" sensors can simply be replaced.

Memosens

Optimum availability of the point of measurement is achieved by using pre-calibrated sensors with contactless Memosens technology. Calibration is no longer carried out on site but under reproducible conditions in the laboratory with the new MemoSuite software tool. Individual sensor data are always directly assigned to each Memosens sensor.



MANUFACTURE OF FOOD ADDITIVES

Measurement of pH value in milk-based products

Additives are added to foods to maintain or improve their safety, freshness, taste, texture, or appearance. Some food additives have been used for preservation for centuries, such as salt in sausages. Many others have only been developed to optimize large-scale food production. They are needed to keep processed foods in good condition and safe on their way from the factories or commercial kitchens to the consumer. Food additives can be obtained from plants, animals, or minerals using a variety of processes such as fermentation, physical methods, and enzymatic reactions, or they can be synthetically produced.

When producing milk-based food additives, the evaporation of the watery part of the medium results in a solid. The process requires very accurate pH measurements in the reactor in order to safely monitor the quality of the food additives and optimize the product yield. During the evaporation process, the pH electrodes are very quickly blocked by the process medium. This makes constant pH monitoring during a batch very complicated. Should a pH sensor fail due to blockage during the operation, no longer providing plausible measured values, it has until now not been possible to carry out sensor cleaning/maintenance. Furthermore, the devices used (sensors, fittings, etc.) must be removed, cleaned, and maintained after each batch. Six cCare measuring points were installed at the customer's site and clean the sensors fully automatically during operation, calibrating them if required.

WHY KNICK?
Because with the cCare System, Knick offers a unique solution specially developed for demanding applications. The manufacture of food additives (here milk-based) requires conditions without glass breakage and online monitoring. Knick has showed that we can meet these requirements.

Customer
Leading provider in all areas of human nutrition (food, beverages and food supplements) and part of the world's largest chemicals group.

cCare Fully Automated Sensor Maintenance System

Measuring point

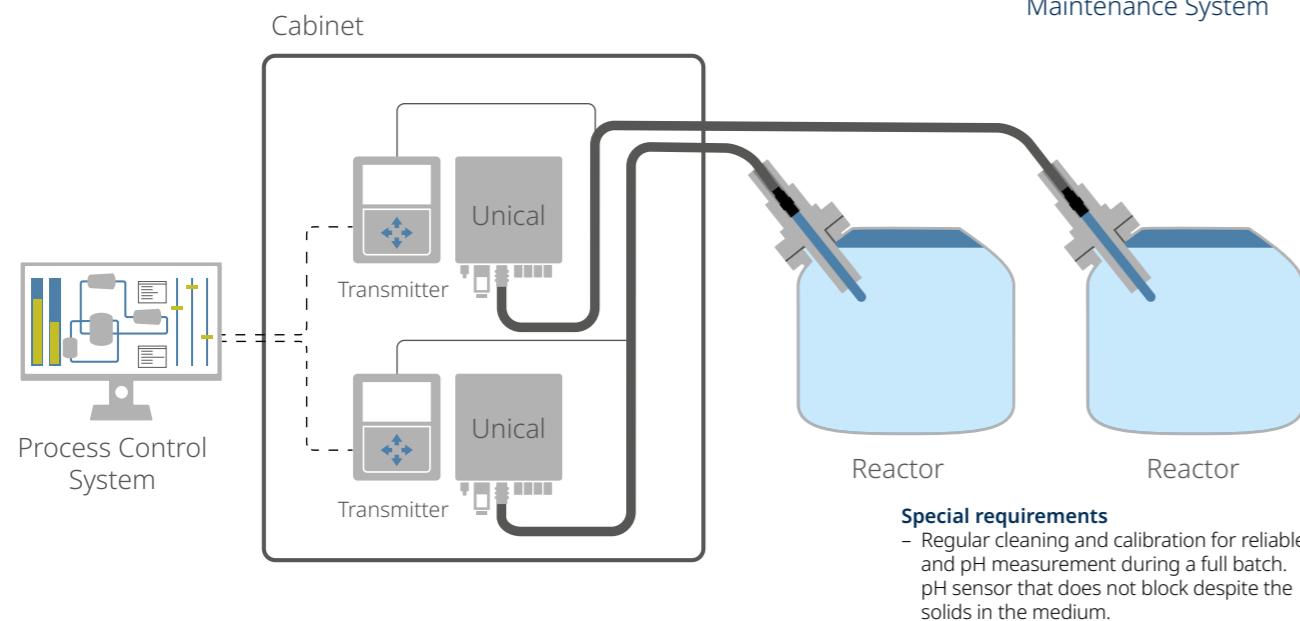

MANUFACTURE OF FOOD ADDITIVES

Applications

PRODUCT	FEATURES	CUSTOMER BENEFIT
Protos	 <ul style="list-style-type: none"> - High resolution graphic display - Corrosion resistant coated stainless steel - 4 wire, ex zone - Full diagnostics - Status messages according to NAMUR 	<ul style="list-style-type: none"> - Various input and output connections for integration into process - Flexible due to various modules for measuring and communication
pH-Sensor SE555	 <ul style="list-style-type: none"> - Up to 135 °C, up to 6 bar - Ceramic junction - Viscous pressurized gel filling - For aggressive media - Memosens technology 	<ul style="list-style-type: none"> - Long lifetime even in harsh conditions - Remote calibration - Sensor/cable connection can be submerged in water (Memosens)
Unical/Uniclean	 <ul style="list-style-type: none"> - Automatic cleaning and calibration of pH measuring point - Timer or remote controlled - Available in ex zone - Easy installation and operation 	<ul style="list-style-type: none"> - All media (air, water, cleaning and calibration solutions) are connected in one tubing and by one connector plug - Local switch for maintenance
Retractable fitting Ceramat WA160	 <ul style="list-style-type: none"> - Ceramic lock-gate sealing for long life in corrosive and abrasive suspensions - No gaskets, lowest maintenance - Available in ex zone - Immersion depth up to 2000 mm 	<ul style="list-style-type: none"> - Lowest maintenance - Long service life - Effective cleaning and protection of sensor

CLEANING

Fully automatic cleaning with patented cyclone rinsing



CALIBRATION

Fully automatic calibration and adjustment of the pH sensor

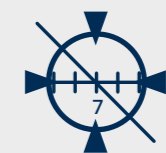

CONSERVATION

Extension of the sensor service life through regular maintenance





MANUFACTURE OF MICRONUTRIENTS IN THE TBCC REACTOR

pH value measurement in Cu-Zn-Mn slurry

Micronutrients are essential nutritional components needed by organisms for physiological functions and to maintain health throughout their life. Minerals for humans and animals include 13 elements that come from the earth and cannot be synthesized by living organisms, such as calcium and iron. The micronutrient requirements of animals also include vitamins, which are organic compounds that are needed in microgram or milligram amounts.

A cCare system was installed in the recirculation line of a TBCC reactor (TriBasic Copper Chloride) in micronutrient production for cattle, pigs, poultry, and other farm animals. The process medium is a slurry containing copper oxide, zinc oxide, and magnesium oxide and which is unfortunately also deposited on the sensor, therefore requiring frequent cleaning during the process. The pH value is an important measured value for the course of the process, but has so far only been monitored by random samples taken with a portable measuring device. The user wanted to minimize the training required for the engineers to clean and calibrate the pH sensors used. The cleaning and calibration processes are now carried out fully automatically by the cCare system which can be controlled directly via the PLC in the control room.

WHY KNICK?
Because the customer was very interested in an automated system that would significantly reduce the training required for the users. It wanted the opportunity to control a system via PLC and to start programs as and when required. With the cCare system, Knick offers exactly the functions that the customer wants. In addition to the reduction of training, system availability was further increased by the cCare system.

Customer
Manufacturer of feed additives based on copper, zinc, and manganese for cattle, pigs, poultry, and other farm animals in the USA

cCare

Fully Automated Sensor Maintenance System

Measuring point

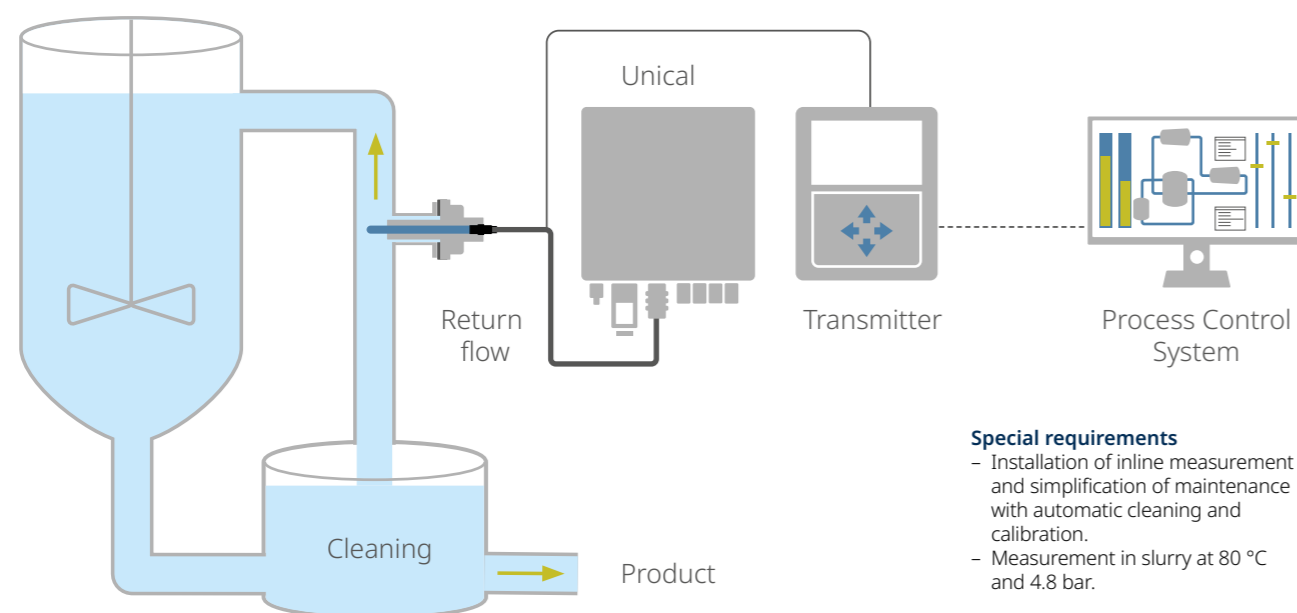

Special requirements

- Installation of inline measurement and simplification of maintenance with automatic cleaning and calibration.
- Measurement in slurry at 80 °C and 4.8 bar.

MANUFACTURE OF MICRONUTRIENTS IN THE TBCC REACTOR

Applications

PRODUCT	FEATURES	CUSTOMER BENEFIT
Protos	 <ul style="list-style-type: none"> - High resolution graphic display - Corrosion resistant coated stainless steel - 4 wire, ex zone - Full diagnostics - Status messages according to NAMUR 	<ul style="list-style-type: none"> - Various input and output connections for integration into process - Flexible due to various modules for measuring and communication
pH-Sensor SE554	 <ul style="list-style-type: none"> - Up to 130 °C, up to 10 bar - 2x open hole - Solid polymer - For heavy industrial application with a lot of impurities and precipitations - Memosens technology 	<ul style="list-style-type: none"> - Long lifetime even in harsh conditions - Remote calibration - Sensor/cable connection can be submerged in water (Memosens)
Unical/Uniclean	 <ul style="list-style-type: none"> - Automatic cleaning and calibration of pH measuring point - Timer or remote controlled - Available in ex zone - Easy installation and operation 	<ul style="list-style-type: none"> - All media (air, water, cleaning and calibration solutions) are connected in one tubing and by one connector plug - Local switch for maintenance
Manual Retractable Fitting SensoGate WA130	 <ul style="list-style-type: none"> - Manually operated retractable fitting for various sensor types - 100 % sealed against process medium in any position of movement - Various materials and process connections available 	<ul style="list-style-type: none"> - Cleaning, calibration and change of sensor without process interruption - Highest safety due to special interlocking mechanism

PRODUCT HIGHLIGHT

SensoGate

Manual and automatic retractable fittings with pioneering design innovations.

The patented lock-gate principle reliably prevents leakage of process medium during probe movement, since the rinse and calibration chambers are sealed to the process at all times. Gasket cleaning during the movement and the gimbal bearing of the immersion tube significantly extend the service life of the gaskets.





MONITORING OF SALINE WASTEWATER

Optical measurement in crystallization and flotation

Around 25 million tons of potash are mined in Germany alone. Fertilizers and basic chemicals are produced from the salts obtained underground. After the raw salt has been mined, it must be prepared and purified for further use. This process requires large volumes of water, so millions of tons of wastewater are produced within a year. Unfortunately, this wastewater is heavily contaminated with salts, so disposal is very difficult. There are only two options for disposal: 1. immersion into the ground or 2. the more advantageous reprocessing and discharge into a nearby river. The permitted salinity for discharge into public waterways is controlled by official regulations.

A company that treats 7 million tons of wastewater per year uses 8 cCare systems with optical probes to prove its compliance with statutory regulations through inline measurements. In the process steps "fractional crystallization" and "flotation," the systems monitor the salinity, which in this application can only be measured using an optical method. The optical probes must be cleaned regularly to remove deposits on the optics which could distort the measurement result. The control unit cleans the optical probe fully automatically at an interval specified by the customer.

WHY KNICK?
 Because the measuring task in this application can only be measured using an optical probe. The Ceramat WA153 is the only retractable fitting available on the market which can accommodate optical probes and clean them automatically using a cCare system.
 Due to the unique ceramic seal, the fitting also does not have any of the annoying seams of an immersion tube, enabling the optical probe to look freely into the process.

Customer
 Manufacturer of salts, fertilizers, and basic chemicals.

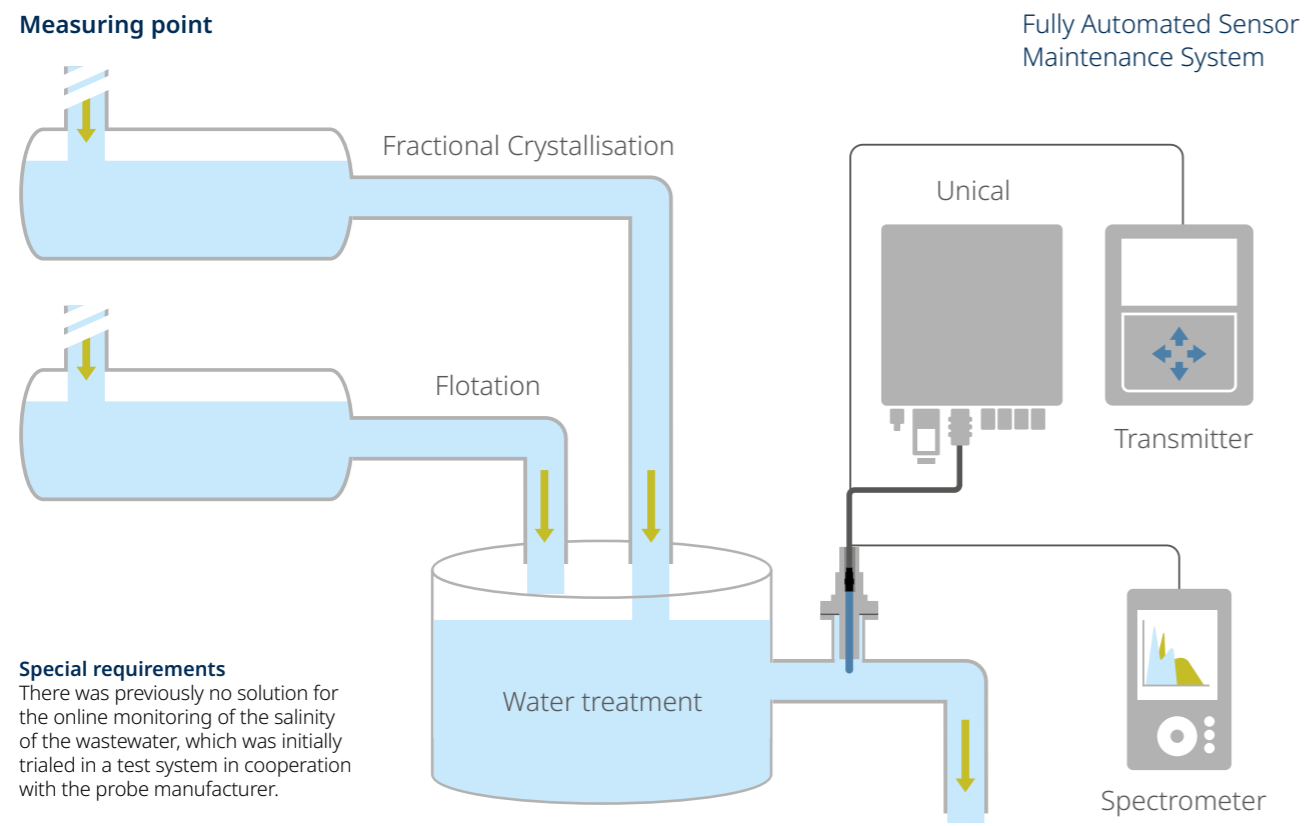

cCare
 Fully Automated Sensor Maintenance System



Special requirements
 There was previously no solution for the online monitoring of the salinity of the wastewater, which was initially trialed in a test system in cooperation with the probe manufacturer.

MONITORING OF SALINE WASTEWATER

Applications

PRODUCT	FEATURES	CUSTOMER BENEFIT
Protos	 <ul style="list-style-type: none"> - High resolution graphic display - Corrosion resistant coated stainless steel - 4 wire, ex zone - Full diagnostics - Status messages according to NAMUR 	<ul style="list-style-type: none"> - Various input and output connections for integration into process - Flexible due to various modules for measuring and communication
ATR Sensor	<ul style="list-style-type: none"> - See probe manufacturer specifications 	<ul style="list-style-type: none"> - Salinity measurement
Unical/Uniclean	 <ul style="list-style-type: none"> - Automatic cleaning and calibration of pH measuring point - Timer or remote controlled - Available in ex zone - Easy installation and operation 	<ul style="list-style-type: none"> - All media (air, water, cleaning and calibration solutions) are connected in one tubing and by one connector plug - Local switch for maintenance
Manual Retractable Fitting Ceramat WA153	 <ul style="list-style-type: none"> - Adapted design for use of even heavy optical sensors up to Ø 12 mm - Special device for the use of fiber optic cables on the sensor 	<ul style="list-style-type: none"> - Lowest maintenance - Ceramic lock-gate sealing for long service life - Effective cleaning and protection of sensor

PRODUCT HIGHLIGHT

RETRACTABLE FITTING FOR OPTICAL SENSORS

Moving and automatic cleaning

Ceramat is appropriate for the use of optical probes of modern process spectroscopy. Important here is the completely unobstructed view of the sensor into the process. The Ceramat WA153 holds optical probes with a diameter of 12 mm. Solutions for heavy optical probes are also available. The decoupling of the Ceramat rotary movement prevents the optical fiber of the optical sensor from twisting. Removal of the optical sensor takes place in service position for safe process separation. Fully automatic cleaning is carried out via the Uniclean 900 control system.





REFINERY WASTEWATER IN SOUR WATER STRIPPERS

pH value monitoring in sour water

Refineries produce various fuels from crude oil, e.g., for cars or airplanes. For this purpose, the crude oil must be purified and separated into fractions. Various process steps produce acidic wastewater, which must then be treated within the refinery before discharge or reuse. For this purpose, almost all refineries use sour water strippers to remove ammonia (NH₃) and hydrogen sulfide (H₂S). The various sour water flows are collected centrally and processed in series via a heat exchanger and one or more stripper columns. Ammonia and hydrogen sulfide are expelled by a combination of pH regulation and heat supplied (via introduced water vapor).

Solids and hydrocarbons ("oils") are the main contaminants that cause fouling of heat exchangers, stripper columns, and reboilers. This may lead to the loss of stripper capacity up to the restriction of refinery performance or even to system shutdown. Oil carried over into the acidic gas stream can lead to an increased risk of fire due to oil coking of the reactor beds in the plant. Excess oil in the strip water may overload the water treatment plant and pose an environmental risk. When carrying out maintenance, users may be exposed to the highly volatile hydrogen sulfide H₂S. The conditions in the sour water stripper are regulated by the pH value of the process medium, which is measured before the stripper unit. The pH value at the end of the process is used for monitoring stripper performance.

WHY KNICK?
 Because the customer was convinced by the safety functions as well as the well-thought-out design of the SensoGate retractable fitting. Safe separation from the process avoids a health risk for employees during maintenance. The rugged design ensures maximum reliability of the measuring point.

Customer
 Globally active mineral oil and energy company.

Measuring point

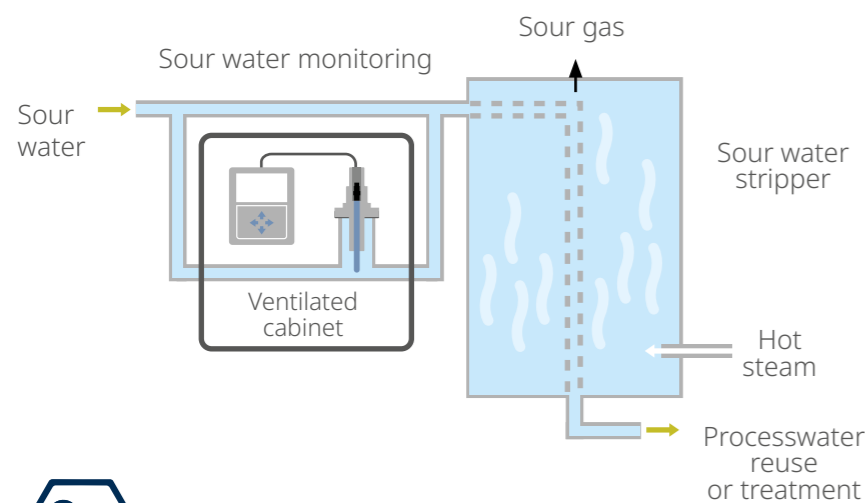





Special requirements

- The substances contained in the medium influence the performance of the pH sensors used (sludge, hydrocarbons, heavy metals, etc.). Regular cleaning mandatory.
- pH values are between 6-9, temperatures up to 30 °C.
- Hazardous area (Ex)

REFINERY WASTEWATER IN SOUR WATER STRIPPERS

Applications

PRODUCT	FEATURES	CUSTOMER BENEFIT
Stratos Pro	 <ul style="list-style-type: none"> - 2-wire-analyzer for pH / ORP, conductivity or oxygen - For analog, digital and Memosens-sensors; automatic sensor identification - High-contrast widescreen display with colored backlighting 	<ul style="list-style-type: none"> - Comprehensive features - Intuitive operation with pictograms and continuously plain-text ticker line - Shatter-proof and corrosion-resistant housing
pH-Sensor SE558	 <ul style="list-style-type: none"> - Designed for low conductivity - Viscous gel filling - Inbuilt KCl reservoir - 3 x ceramic junction 	<ul style="list-style-type: none"> - No external KCl reservoir needed - No contact problems due to Memosens technology
Manual Retractable Fitting SensoGate WA131M	 <ul style="list-style-type: none"> - Cleaning, calibration and change of sensor without process interruption - Highest safety due to special interlocking mechanism 	<ul style="list-style-type: none"> - Manually operated retractable fitting for various sensor types - 100 % sealed against process medium in any position of movement - Various materials and process connections available
Flow-through fitting ARF203	 <ul style="list-style-type: none"> - Compact flow-through fitting made of stainless steel 1.4571 or Hastelloy C 22 - For sensors and fittings with G 1 1/4"/ 25-mm Ingold socket or oder SensoGate WA130 und WA131M 	<ul style="list-style-type: none"> - Stainless steel 1.4571 for high temperatures and pressures.; Hastelloy C22 for chemically very demanding processes - Flow direction 90° or 180° (adjustable with screw plug)

PRODUCT HIGHLIGHT

THOUGHT OUT MODULAR SYSTEM

Flow through fitting ARF203 with SensoGate WA131M

Knicks entire range of fittings has a consistent modular design. The portfolio includes static fittings such as immersion, inline and flow fittings as well as the SensoGate and Ceramat retractable fittings. The modular system is well thought out down to the last detail with a wide variety of materials and a large range of process adaptations. The modularity allows the fitting to be adapted to any application.





MOBILE MEASUREMENT IN WASTE OIL BEFORE RECYCLING

pH and conductivity for monitoring

Many industrial and small-scale manufacturers use oil as an operating resource. In some cases, very large quantities of waste oil are produced, which must be disposed of. Typical areas in which waste oil is produced include industry, workshops, oil collection points, and even private households. The waste oil can be processed/recycled on an industrial scale, so that it can be reused, e.g., as fuel for ships. The oil collected at the collection points must be pumped out using a specially equipped tanker truck and then safely transferred to the recycling plant.

The waste oil is often contaminated with aqueous components that must be separated during processing. These are known impurities that can be disposed of separately after separation from the organic phase. Unfortunately, it is now often the case that companies "mix" components into the waste oil, the individual disposal of which is time-consuming or expensive. For example, acids or cleaning agents may be found in the waste oil, since the disposal of waste oil is comparatively cheap.

The only way to identify these "illegitimate" waste oil mixtures is to provide each individual driver of a waste collection vehicle with a measuring device that can detect such impurities prior to the pumping process.

WHY KNICK?

Because the rugged Portavo 907 hand-held measuring device is used here, which is designed to determine pH and conductivity measured values. This enables the two measured values to be recorded in parallel, even before the waste oil is pumped into the collection vehicle. If, for example, strong acids are introduced into the waste oil, (very) low pH values and high conductivity measured values will be recorded. Waste oil itself would not have these measured values alone, thus avoiding illegal disposal and additional costs for the disposal company.

Customer

Companies pumping out waste oil at various collection points and subjecting it to a recycling process.

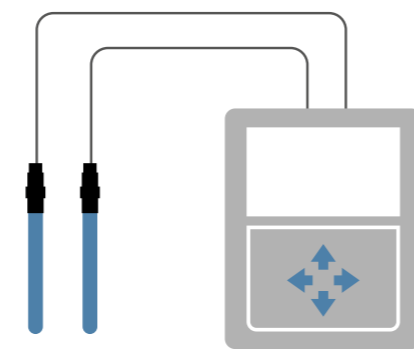

Portavo Portable

Special requirements

A mobile and simple measurement of pH and conductivity, which can be easily carried out on site by the driver of the waste collection vehicle.

Measuring point

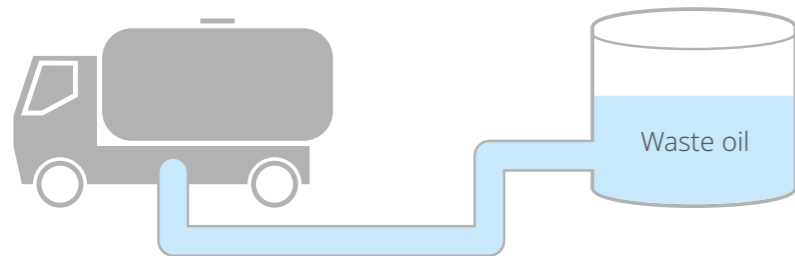

Disposal vehicle

MOBILE MEASUREMENT IN WASTE OIL BEFORE RECYCLING

Applications

PRODUCT

Portavo 907 Multi



FEATURES

- Portable multiparameter analyzer for digital pH/ORP, conductivity, and oxygen sensors with Memosens technology
- simultaneous measurement with Memosens sensors
- Measurement data display/storage in the device

CUSTOMER BENEFIT

- pH calibration procedure with a fixed process cycle
- Robust, practical, comfortable
- Li-ion battery, direct via USB rechargeable

PRODUCT

pH-Sensor SE571



FEATURES

- Up to 130 °C, up to 12 bar
- PTFE ring junction
- Ag/AgCl, incl. silver ion trap and saltreservoir
- No contamination or blocking of the junction
- Memosens technology

CUSTOMER BENEFIT

- Long lifetime even in harsh conditions
- Remote calibration
- Sensor/cable connection can be submerged in water (Memosens)
- SE 571 annular junction resists fouling

PRODUCT

2-Electrode Conductivity Sensor SE615



FEATURES

- 0 ... 20 mS/cm
- up to 80 °C and 4 bar
- Memosens-Technology

CUSTOMER BENEFIT

- Large measuring range thanks to electrodes made from low polarized special graphite
- Integrated temperature sensor for automatic temperature compensation

PRODUCT HIGHLIGHT

MemoView and Portavo

Mobile tool for the contactless, on-site visualization of Knick MS measuring points without a display.



Mobile check of Sensor and Measuring point. Without Process interruption

With MemoView, Memosens online measuring points without on-site display (e.g., in conjunction with MemoRail) can be queried contactless during operation. Users simply push MemoView onto the Memosens sensor connection and all the values and sensor data are displayed on the Portavo mobile analyzer.

Comprehensive communication

With the Portavo mobile process analyzer, sensor data and up to 10,000 measured values can be recorded and saved directly via MemoLog. This makes it possible to conveniently manage the recorded values everywhere.

Optimized maintenance

MemoView is ideal for on-site maintenance and read out of calibration data. And in systems with Protos and Stratos Multi transmitters, MemoView can be used to check the sensors on site.

cCare

Fully Automated Sensor Maintenance System

CONTROLLER

Electropneumatic function with service-friendly concept. Can be used directly in hazardous locations. Fully automatic, modular, low-wear and low-maintenance operation.



TRANSMITTER

Central programming and operating unit of the system. Simple plain text operation and easy copying of settings. Expandable to fieldbus communication and operation with Memosens, digital, and analog electrodes.



MEDIA CONNECTION WITH MULTIFUNCTION PLUG

Central supply of rinsing and calibration liquids in pre-assembled hoses. Quick, easy, and fail-safe installation via a multifunction plug, use of ball valves that reliably prevent media carryover and back-mixing.

MEDIA ADAPTER WITH CONTAINERS AND METERING PUMPS

1-3 containers for cleaning and calibration solutions with wear-free pumps. Container capacity with 3.5 l buffer solution is sufficient for up to 140 calibrations. An additional cleaning or rinsing fluid can be supplied via the external valve in Unical.



SERVICE SWITCH

Central safety switch for immediate retraction of the sensor into the fitting. With warning signal function and active feedback on the actual position of the sensor.



RETRACTABLE FITTINGS

Fittings of the Ceramat or SensoGate series can be used. Modular systems available in various designs (materials, process connections, immersion length, etc.). Adaptable to any process application.



PROCESS ANALYTICS

- > INDUSTRIAL TRANSMITTERS
- > FITTINGS
- > AUTOMATIC CLEANING AND
CALIBRATION SYSTEMS
- > SENSORS
- > PORTABLES
- > LABORATORY METERS



**KNICK
ELEKTRONISCHE MESSGERÄTE
GMBH & CO. KG**

Beuckestraße 22, 14163 Berlin
Phone: +49 30 80191-0
Fax: +49 30 80191-200
info@knick.de